

Infographics

Pongrapee Kaewsaiha
SSRU

Infographics

Information

+

Graphics

Infographics are graphic visual representations of information, data, or knowledge intended to present information quickly and clearly.

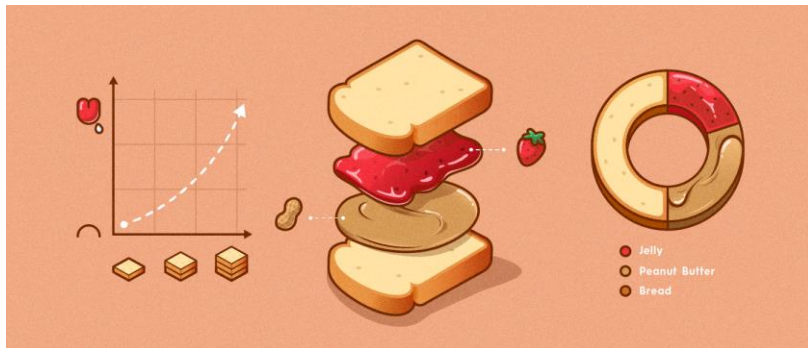

Human recognizes patterns and trends by using visual inspection quicker than using detailed reading.

❖ Just an English lesson before we start ❖

When you write the word “**infographics**”

- There is no space
- Always add the “s” (*use a plural form*) if “**graphics**” is a subjective noun (*noun as a subject*).

Example: computer graphics, infographics

- If it is an appositive noun (*nouns as a modifier*), you may use either singular or plural form.

Example: infographic(s) work, graphic(s) designer

When should we use infographics?

Benefits of TOMATO

Tomatoes are the low-calorie vegetables that offer a range of health benefits, including weight loss and reduced risk of heart diseases. They are the major source of vitamin C, potassium, and vitamin K.

02. Vitamins & minerals

10 mg of calcium
437 mg of potassium
43 mg of phosphorus
25.7 mg of vitamin C
1499 international units (IU) of vitamin A

03. Health benefits

Antioxidant Agent
Rich Source of Vitamins and Minerals
Protects the Heart
Prevents Kidney Stones and Gallstones
Improves Vision
Aids in Digestion
Skin Care

01. Nutrition facts

Calories: 18
Water: 95%
Protein: 0.9 grams
Carbs: 3.8 grams
Sugar: 2.4 grams
Fiber: 1.2 grams
Fat: 0.2 grams



Easy Pasta

Step 1



Step 3



Enjoy

VIRTUAL REALITY



All about
VIRTUAL REALITY

Virtual reality is a technology that immerses an individual in a simulated environment for the purpose of training, entertainment, and other purposes.

Advantages

- 1. Immersive experience
- 2. Data visualization
- 3. Gamification

Disadvantages

- 1. Motion sickness
- 2. Eye strain
- 3. High cost

Applications

- 1. Education
- 2. Entertainment
- 3. Healthcare

Hi to...
It's me...

Me with my father

Mom & Dad with me

Shopping with Grandma

Buying with grandpa

For...

Enjoy

1. To share hot news and announcement

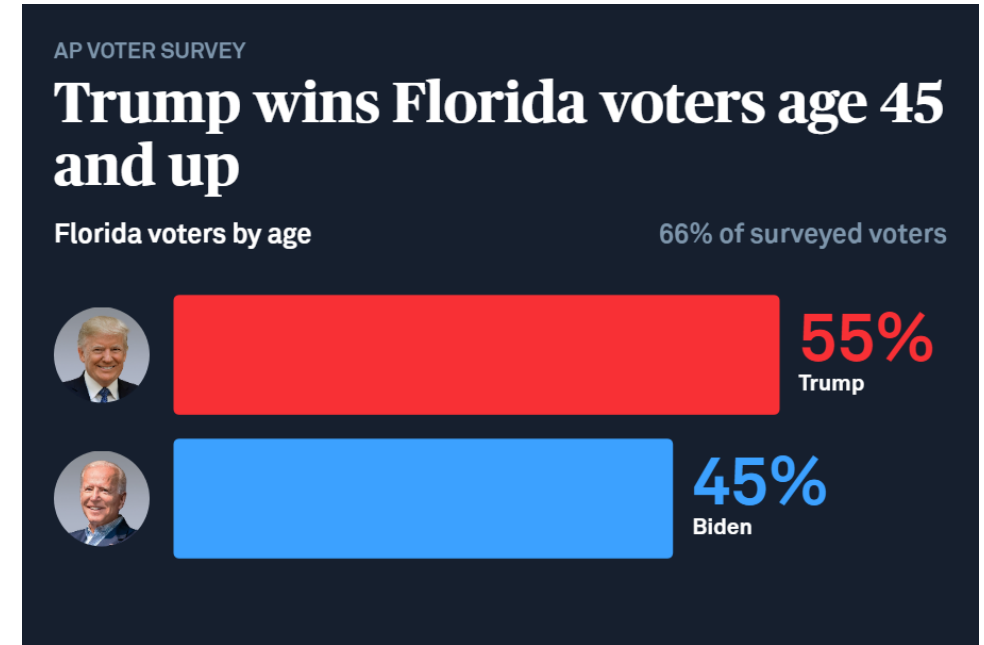

Graphic images draw attention quickly and easily.

2. To teach how to



“A picture is worth a thousand words (Fred R. Barnard, 1921).”

3. To give knowledge

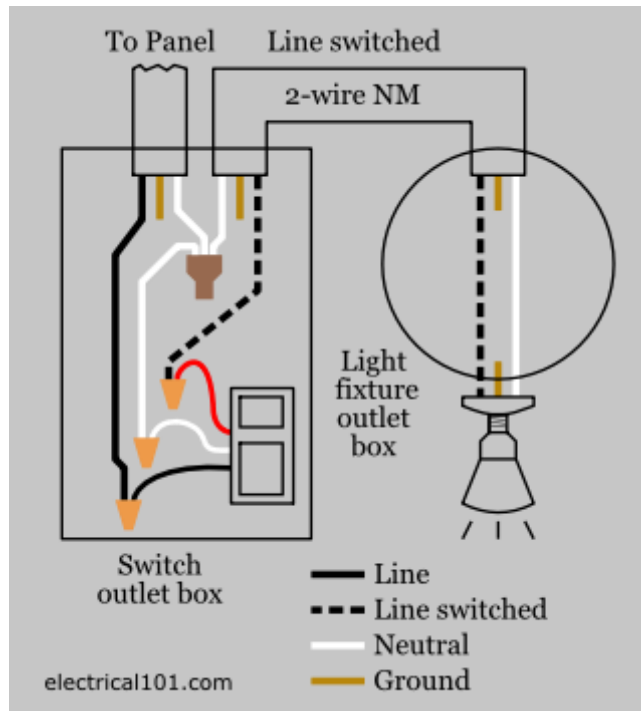

The difference between droplet and airborne transmission

Droplet transmission

Coughs and sneezes can spread droplets of saliva and mucus

Airborne transmission

Tiny particles, possibly produced by talking, are suspended in the air for longer and travel further

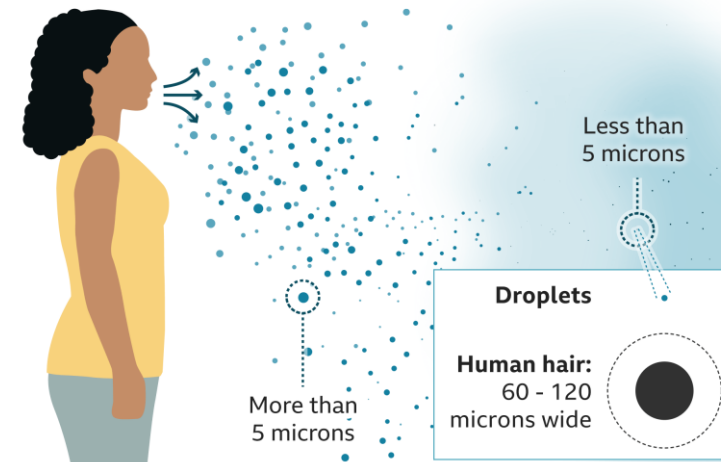

Source: WHO

BBC

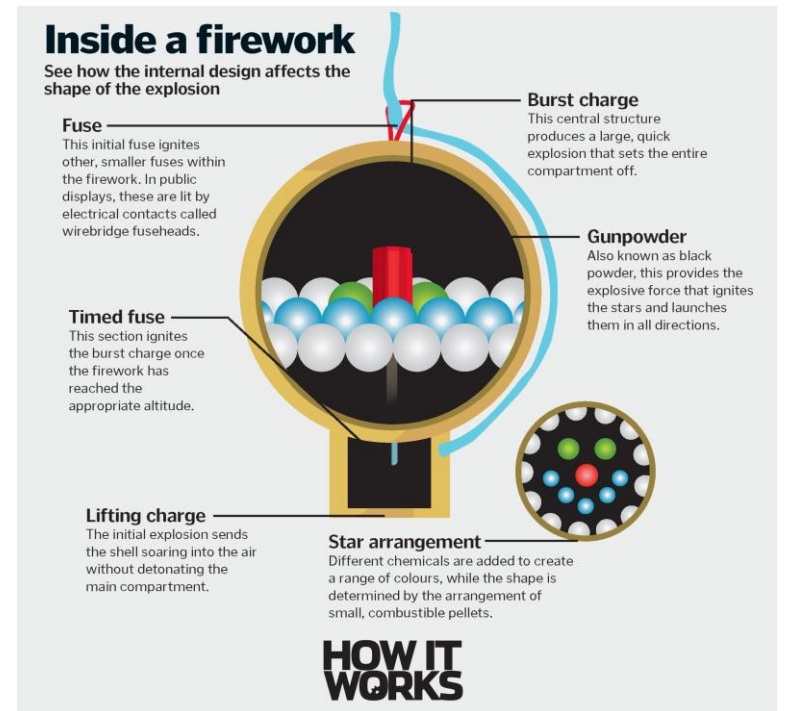

4. To tell a story

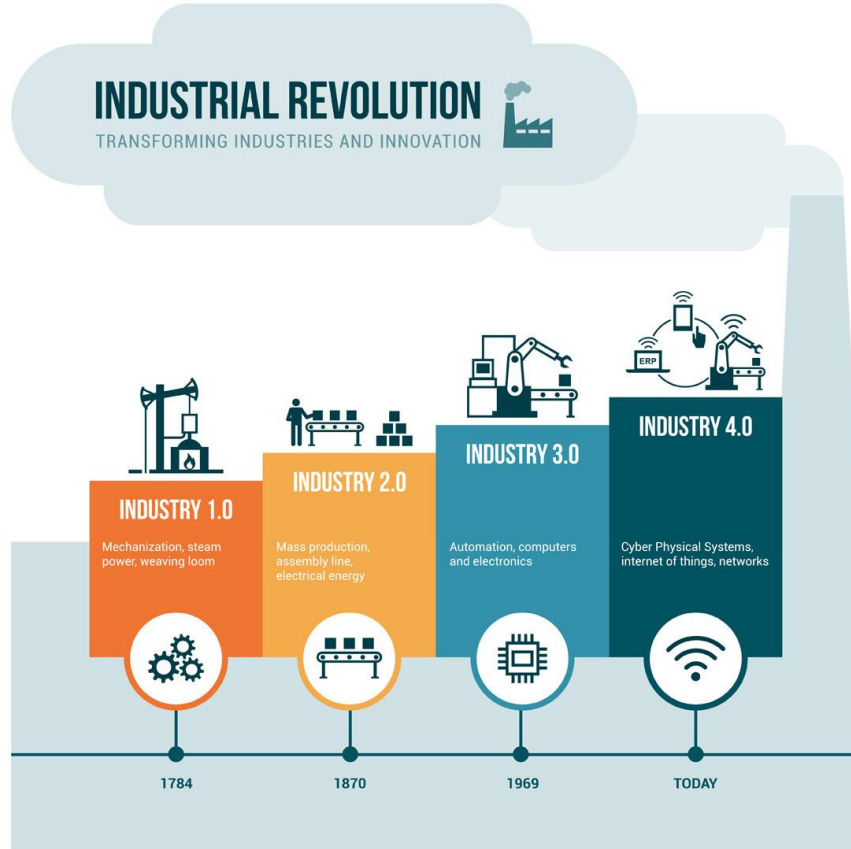

5. To present the research data.

Women are more likely to attend the day classes, while men are more commonly found in the evening class

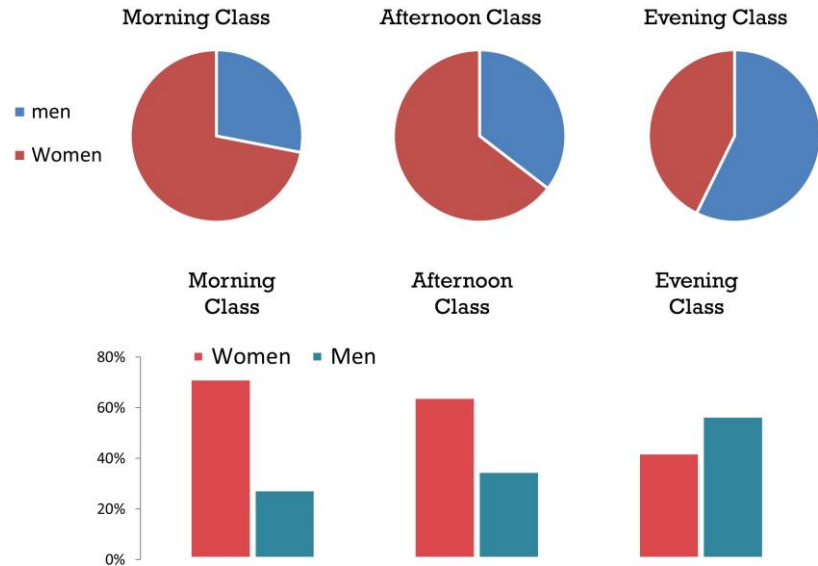

US Teens' Favorite Social Platform

marketing charts

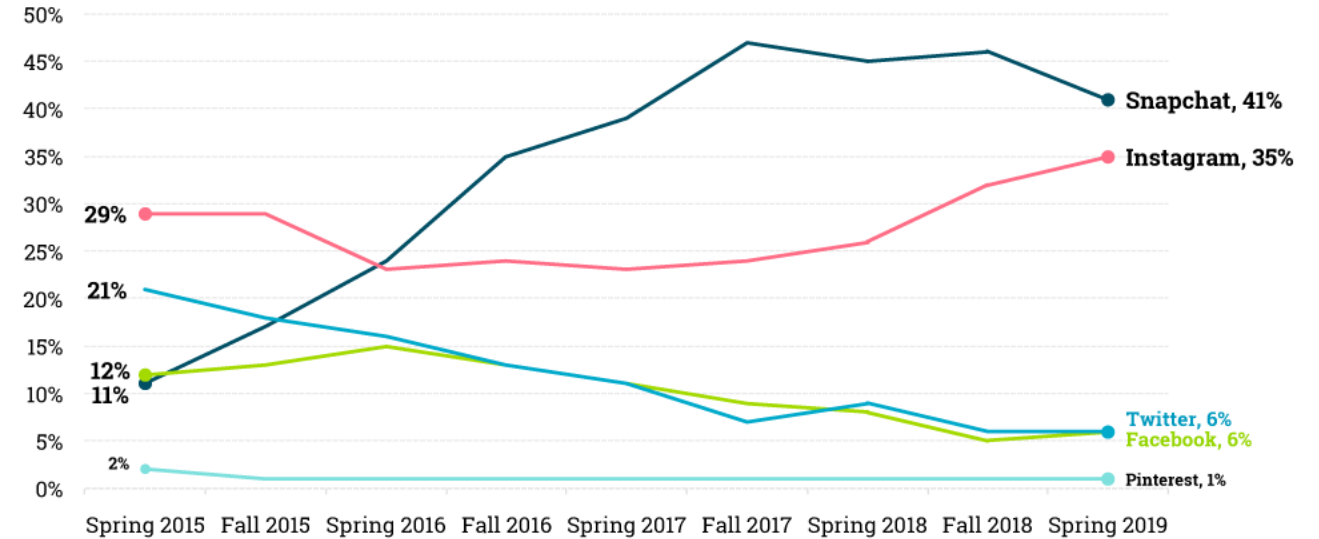

Published on MarketingCharts.com in April 2019 | Data Source: Piper Jaffray

Spring 2019 data based on a survey of 8,000 US teens with an average age of 16.3

Figures show % share of respondents selecting each as their favorite social platform, select responses only

Graphs and charts turn complex data tables into reader-friendly graphics.

6. Encourage behavior change

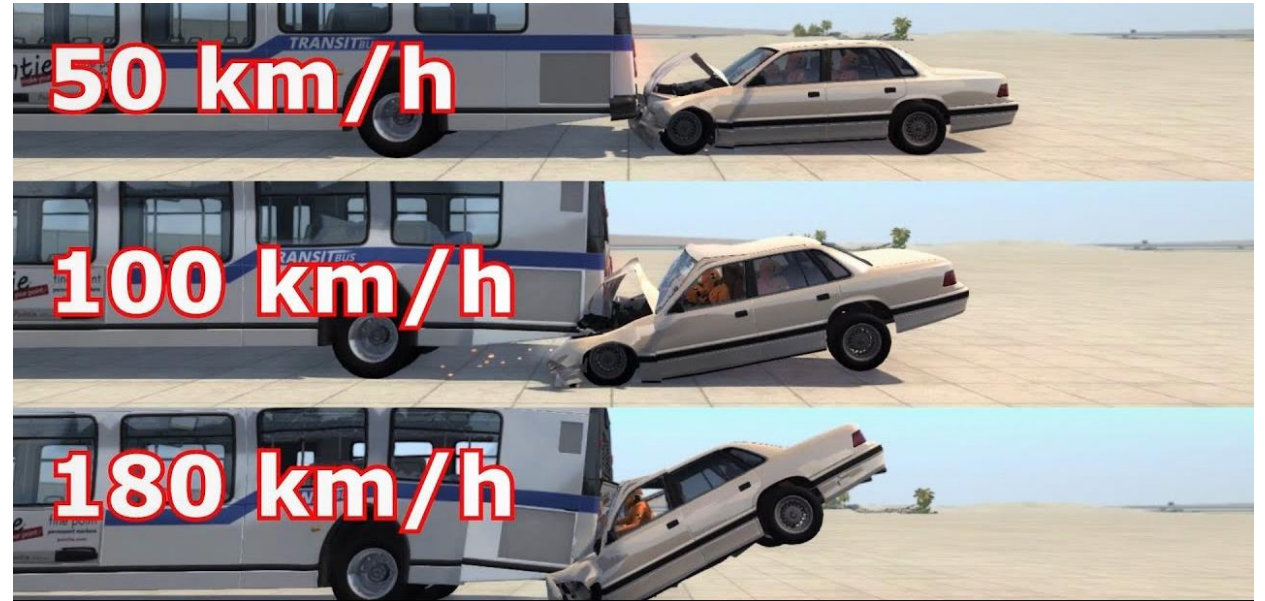
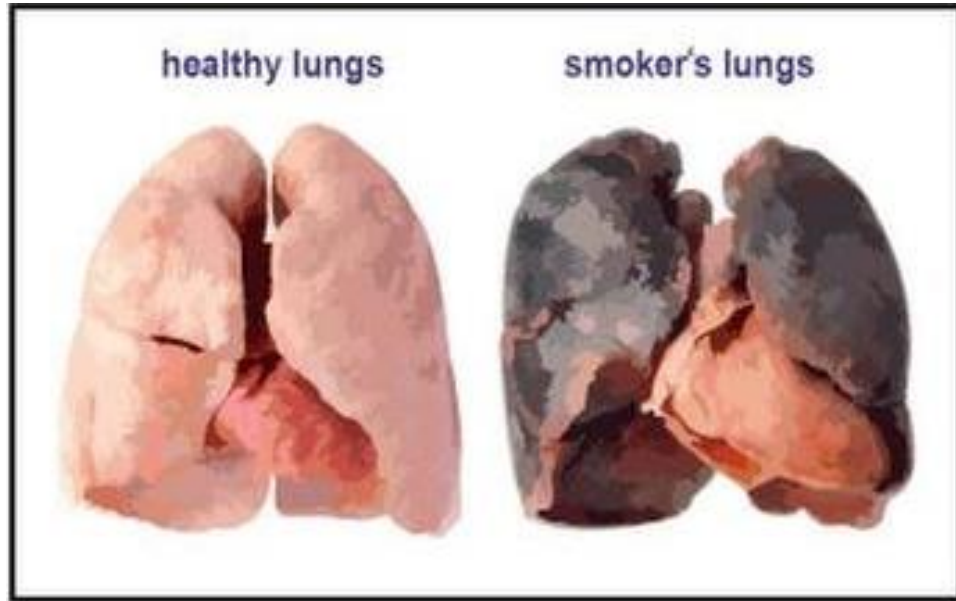

Images have strong impact on human emotion.

7. Promote products and services.

SNEAKERS
\$37
HALF PRICE

- Classic canvas upper
- Comfortable with a cushioned insole for all-day comfort
- Traditional lacing closure
- Breathable
- Measurements: Weight: 15 oz

SMARTPHONE
\$549
PRE-ORDER

- 5.90-inch Display
- Resolution 1125x2436 pixels
- Processor hexa-core
- Front Camera 7 megapixel
- Rear Camera 12 megapixel
- Battery Capacity 2716mAh

SANDWICH
\$3.50
HOT DEAL

DISH OF THE DAY

- Grilled patty (ground beef)
- Fresh bun with sesame
- Red onion
- Juicy tomatoes
- Luscious lettuce

COOL CHAIR
\$140
HUGE SALE

- Indoor and Outdoor use
- Various color are available
- Ergonomic with cashmere
- 3 year warranty
- Measurements: 72 cm x 77 cm x 82

BIG SALE
ENJOY on **1000** PRODUCTS

Your Monthly Savings

LOGO HERE

PICK OF THE MONTH
NOVEMBER 2018

ICON

Product name Style & Size	Product name Style & Size	Product name Style & Size	Product name Style & Size
\$99.99 100.00	\$99.99 100.00	\$99.99 100.00	\$99.99 100.00

Offer valid from 1 - 5 November, 2018

Graphics need to be more attractive than the rivals.

Templates and Formats



1. Visualized article

Light energy emitted by the sun warms the earth's surface, which reflects the energy as heat that warms the atmosphere. Much of the heat is captured by greenhouse gas molecules such as water, carbon dioxide, and methane.

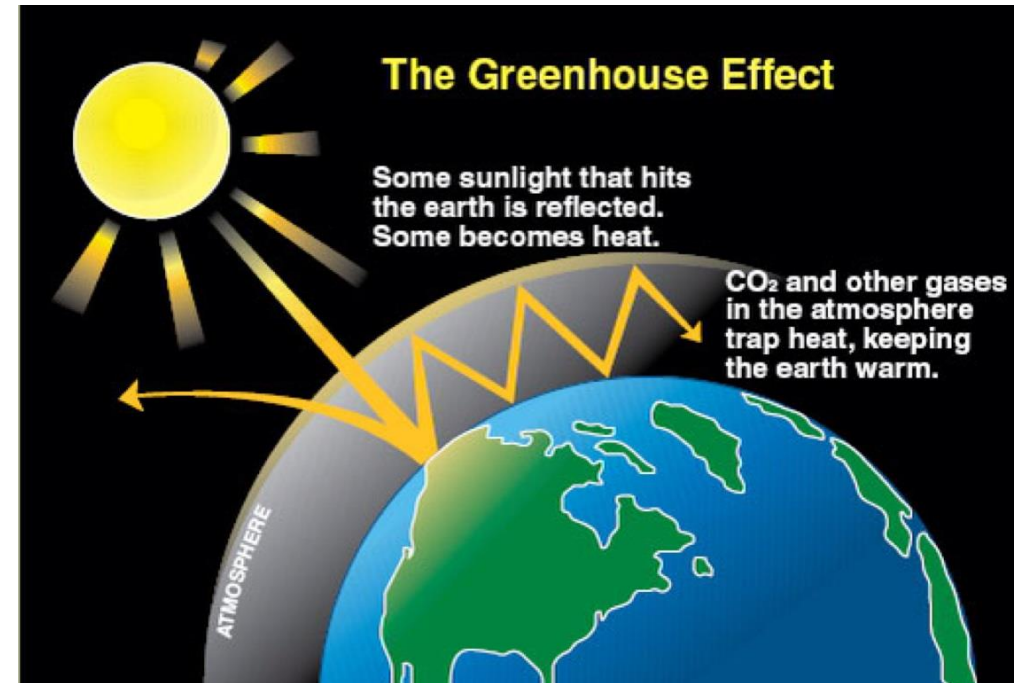
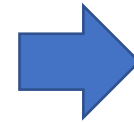

This is the most common infographic type.
Just use graphics to represent a lengthy article.

2. Listed

Numbered List Layouts for PowerPoint

1 • This is a sample text.
• Insert your desired text here

2 • This is a sample text.
• Insert your desired text here

3 • This is a sample text.
• Insert your desired text here

4 • This is a sample text.
• Insert your desired text here

5 • This is a sample text.
• Insert your desired text here

6 • This is a sample text.
• Insert your desired text here

7 • This is a sample text.
• Insert your desired text here

8 • This is a sample text.
• Insert your desired text here

Free PPT Templates: Allppt.com

You can download professional PowerPoint diagrams for free

01 **Content Here**
Get a modern PowerPoint Presentation that is beautifully designed. Easy to change colors.

02 **Content Here**
Get a modern PowerPoint Presentation that is beautifully designed. Easy to change colors.

03 **Content Here**
Get a modern PowerPoint Presentation that is beautifully designed. Easy to change colors.

04 **Content Here**
Get a modern PowerPoint Presentation that is beautifully designed. Easy to change colors.

05 **Content Here**
Get a modern PowerPoint Presentation that is beautifully designed. Easy to change colors.

06 **Content Here**
Get a modern PowerPoint Presentation that is beautifully designed. Easy to change colors.

01 **SHAPE TITLE**
Lorem ipsum dolor sit amet, consectetur adipiscing elit. Integer batus, ante lac in la dignism conneado.

02 **SHAPE TITLE**
Lorem ipsum dolor sit amet, consectetur adipiscing elit. Integer batus, ante lac in la dignism conneado.

03 **SHAPE TITLE**
Lorem ipsum dolor sit amet, consectetur adipiscing elit. Integer batus, ante lac in la dignism conneado.

04 **SHAPE TITLE**
Lorem ipsum dolor sit amet, consectetur adipiscing elit. Integer batus, ante lac in la dignism conneado.

05 **SHAPE TITLE**
Lorem ipsum dolor sit amet, consectetur adipiscing elit. Integer batus, ante lac in la dignism conneado.

Extract keywords or key phrases from the whole message and display using numbers, bullet points, or icons.

This kind of presentation is preferred by teachers around the world.

3. Comparison



Before & After

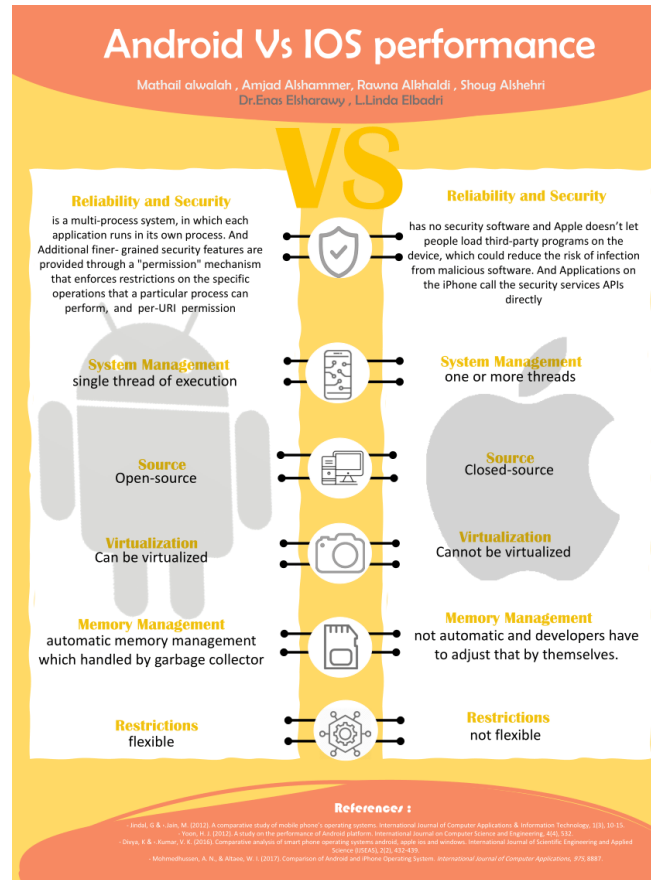

iOS vs Android

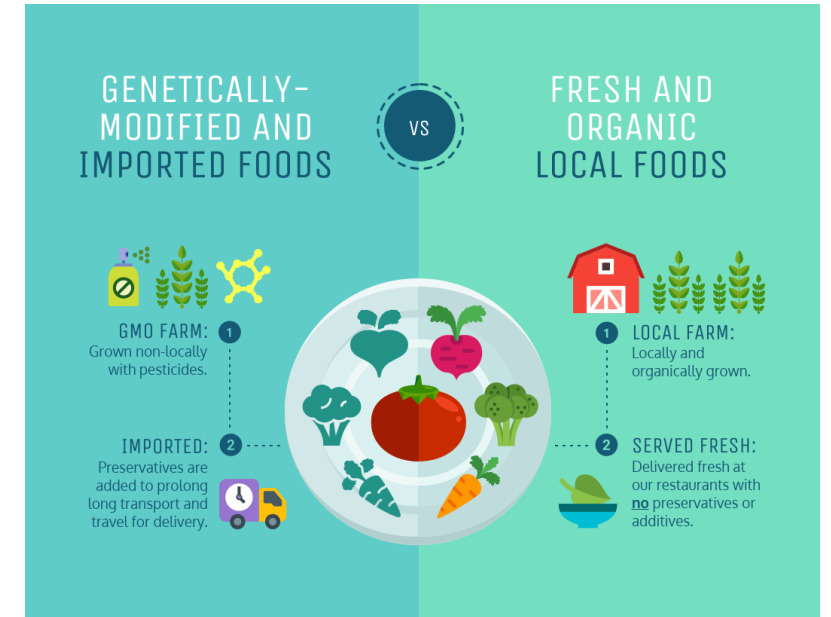

Organic & GMO

4. Structure

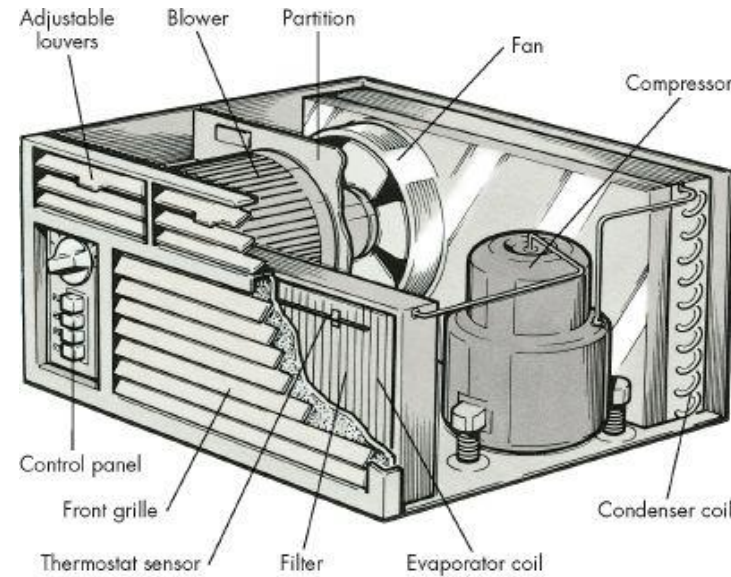
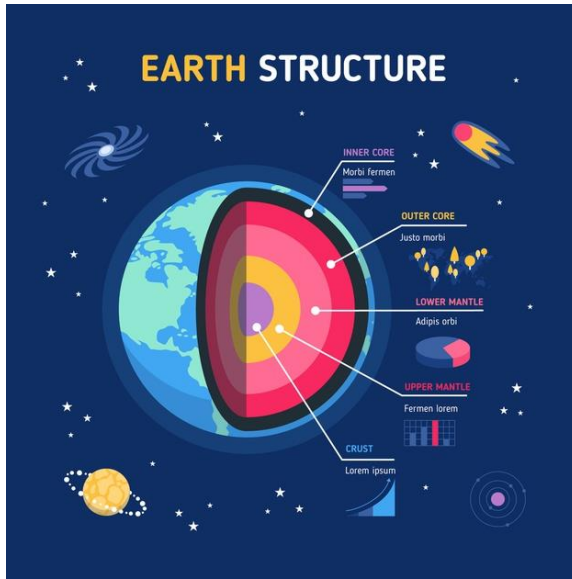

RGB Inside the Camera

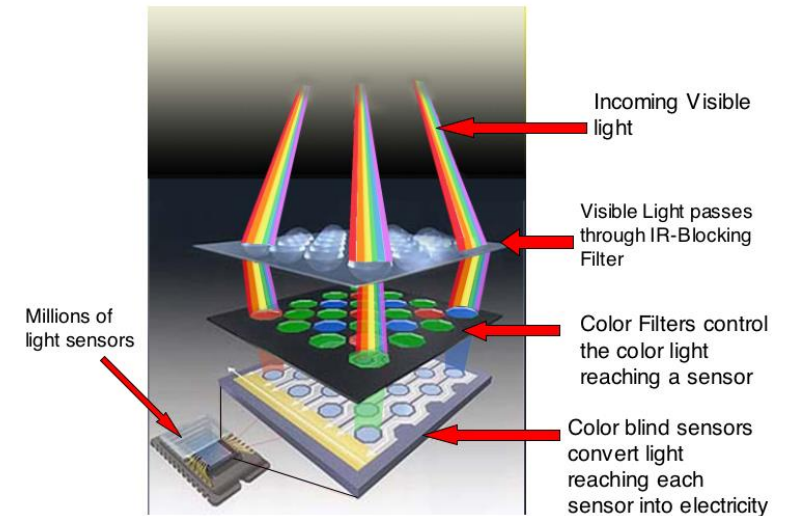

Often used in science and manufacturing to display components inside.

5. Timeline/Roadmap

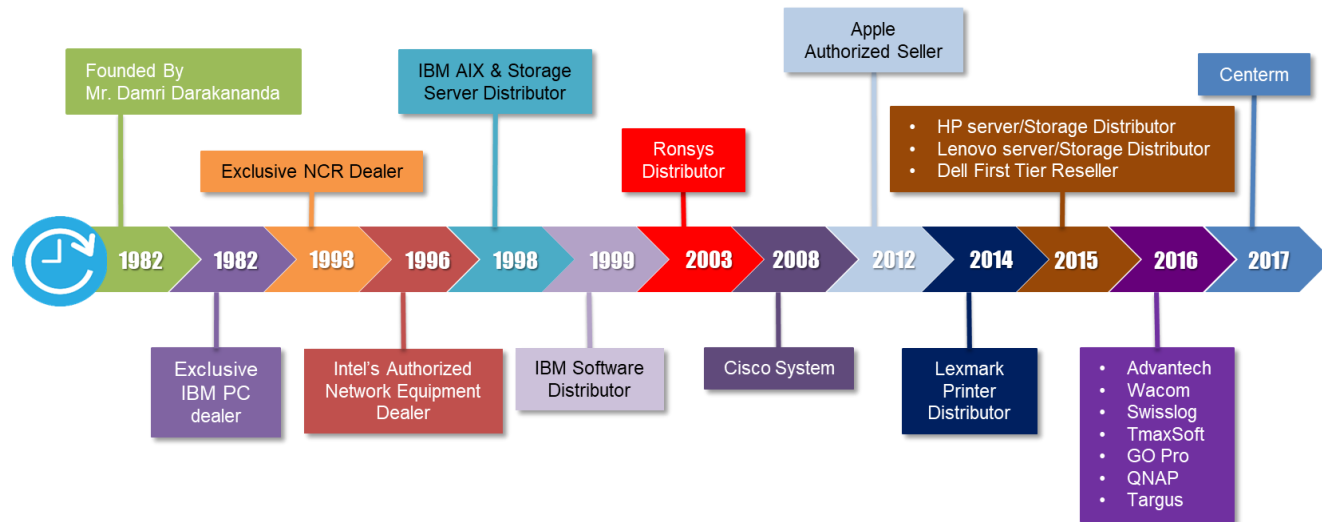





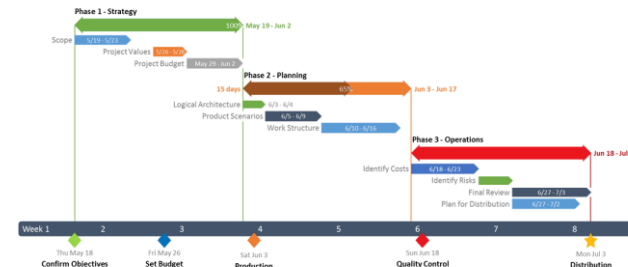

Tell the history of something by using lines, such as people, corporate, and location. Can also be used to inform the roadmap or process (e.g., thesis, recruitment, and business plan).

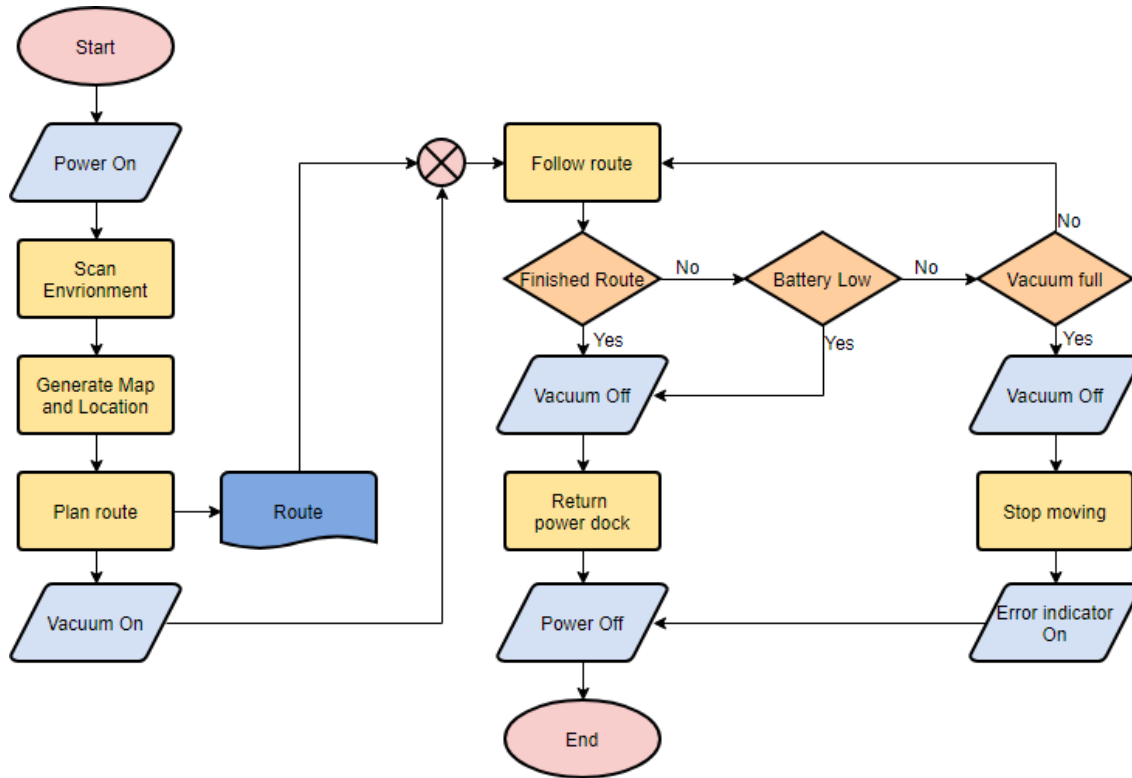
Technique: Use the distance of each point to tell the time interval.



6. Flowchart



Flow Chart Symbol	Meaning	Explanation
	Start and end	The symbol denoting the beginning and end of the flow chart.
	Step	This symbol shows that the user performs a task. (Note: In many flow charts steps and actions are interchangeable.)
	Decision	This symbol represents a point where a decision is made.
	Action	This symbol means that the user performs an action. (Note: In many flow charts steps and actions are interchangeable.)
	Flow line	A line that connects the various symbols in an ordered way.

A flowchart consists of steps, actions, and decisions. It is useful, **and necessary**, in computer programming.

7. Hierarchy

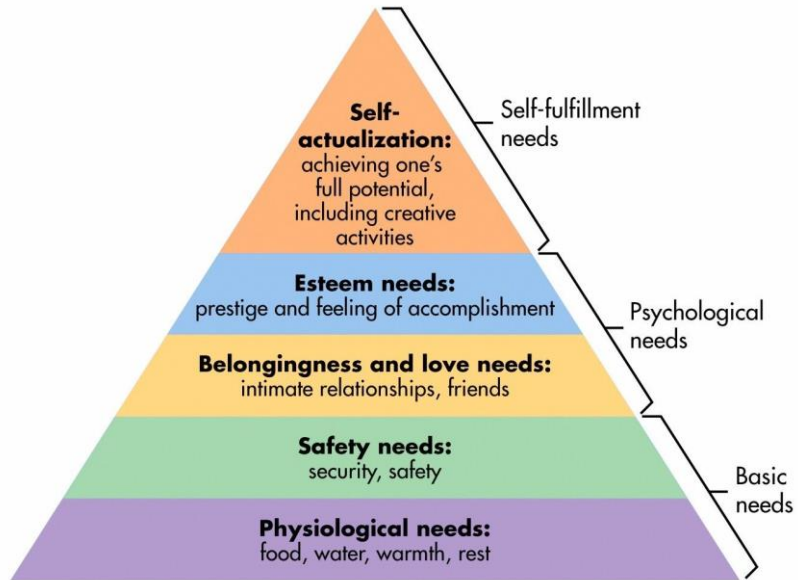

Display levels of importance, ranks, and difficulties.
Also used in organization charts.

8. Chart & Graph

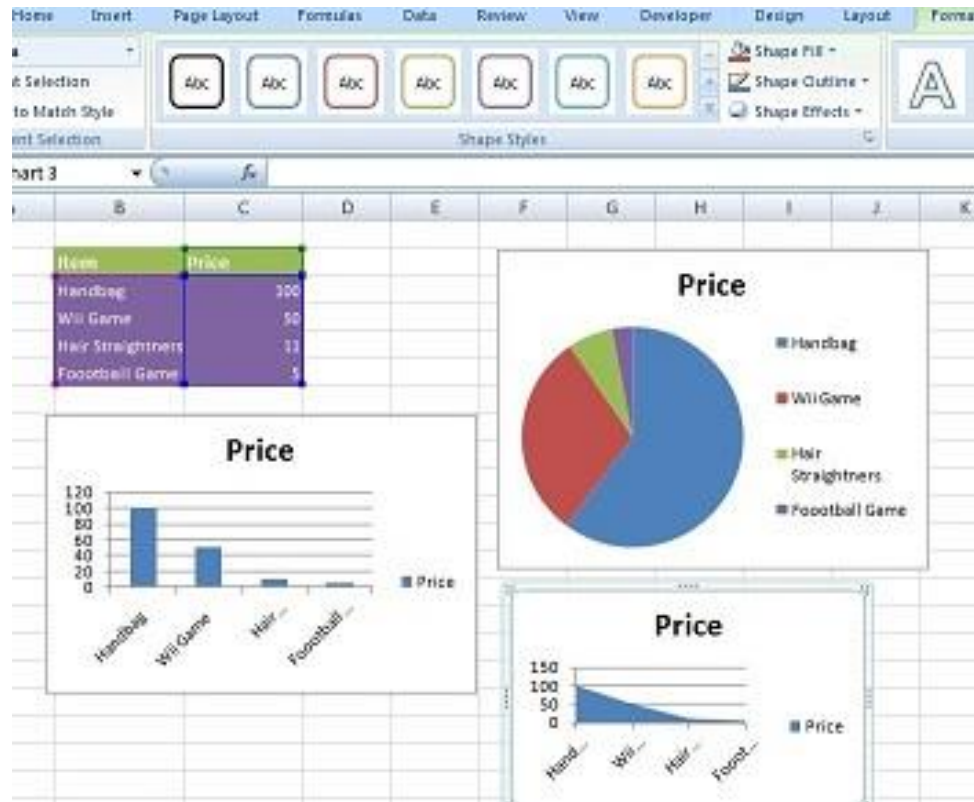

- Created from numerical data.
- Used to visualize the data.
- Commonly used in business, research, and statistics.



Let's get started

1. Short brief

- What is the topic?
- What are infographics for? Children, adults, or some specific people.
- What are the objectives (*see previous slides*)?

Is that for alerting people or just give information, for instance?

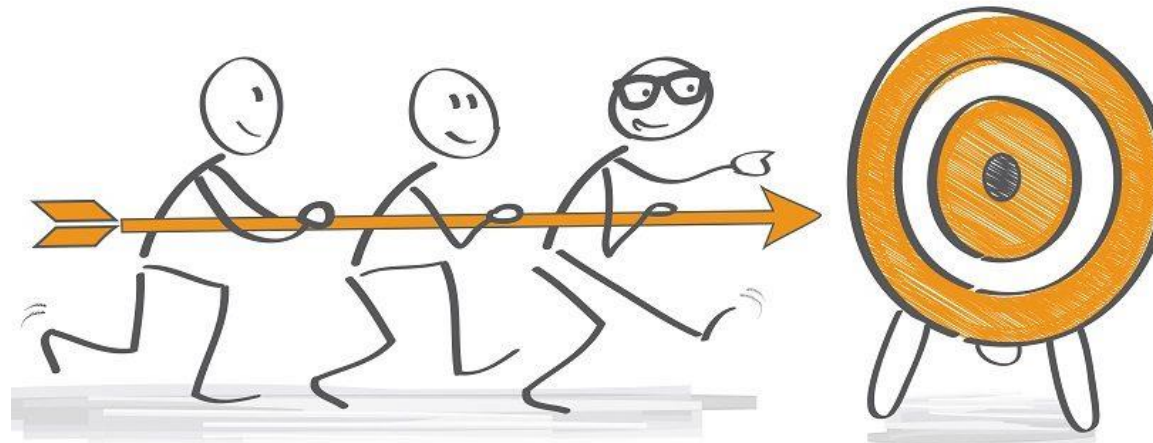

2. Get useful information



Interesting – Present newly updated information, something that is trendy.

Insightful – Present what people want to know, something that is not often revealed to the public, or something that will save people time for searching themselves.



Reliable – Get information from reliable sources. Always give credit or identify sources.

3. Make a conclusive detail

- Infographics are supposed to be short and take little time to remember and understand.
- Detailed information or the whole text needs to be summarized.
- Present only highlights. Discard all useless lengthy details.

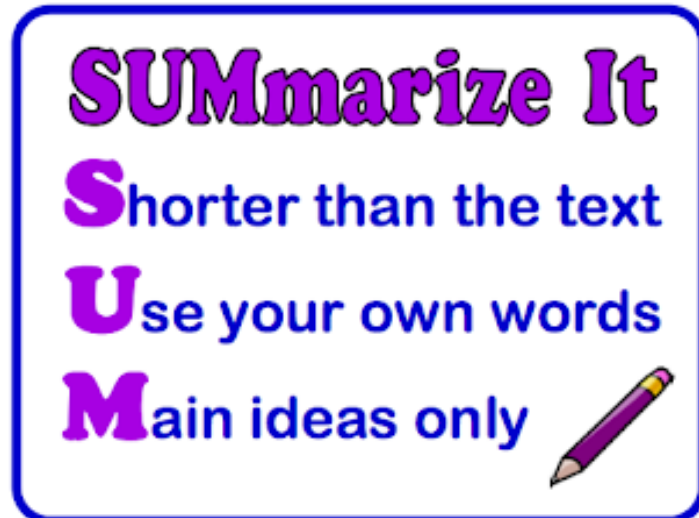

Created by Rachel Lynette Copyright ©2012 all rights reserved

<http://www.readaloudbooks.com>

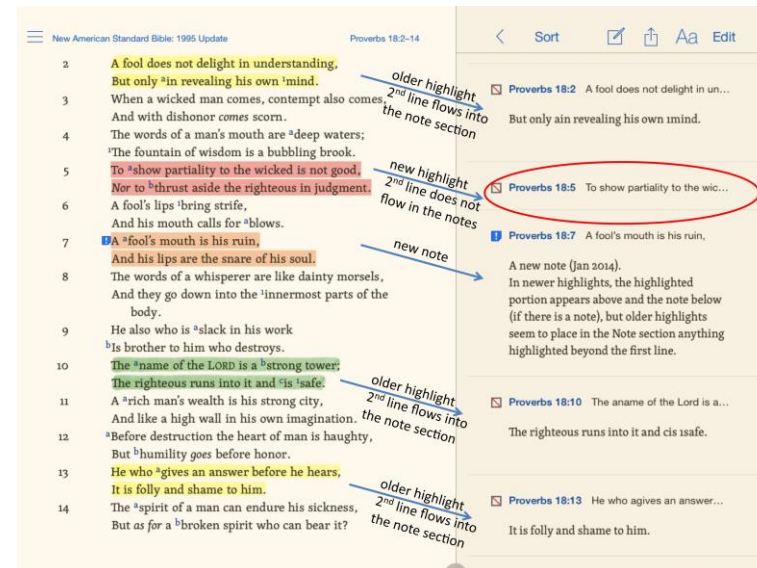

4. Grouping information

Examples

Cause		Effect
1) ..	→	1) ..
2) ..	→	2) ..
3) ..	→	3) ..

Problem		Solution
1) ..	→	1) ..
2) ..	→	2) ..
3) ..	→	3) ..

Introvert	Extrovert
1) ..	1) ..
2) ..	2) ..
3) ..	3) ..

Windows	Mac	Linux
1) ..	1) ..	1) ..
2) ..	2) ..	2) ..
3) ..	3) ..	3) ..

5. Choose the appropriate format

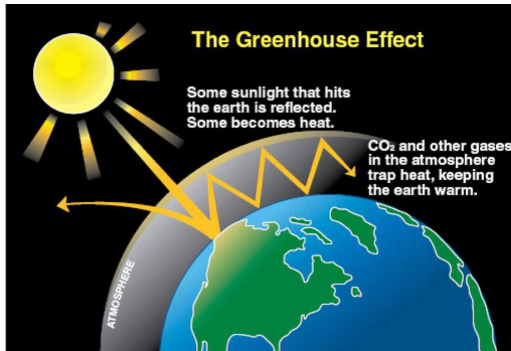

Visualized article

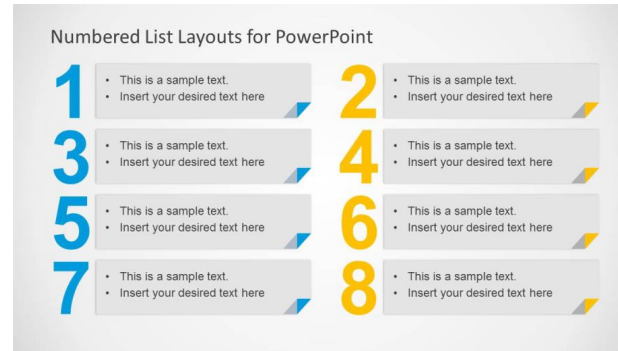

Listed

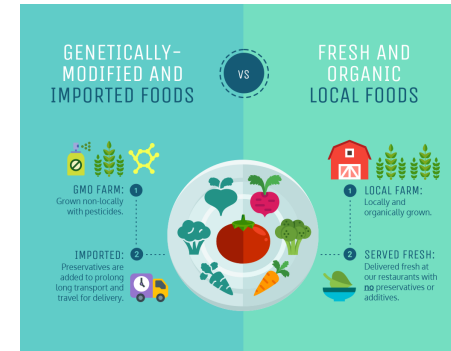

Comparison

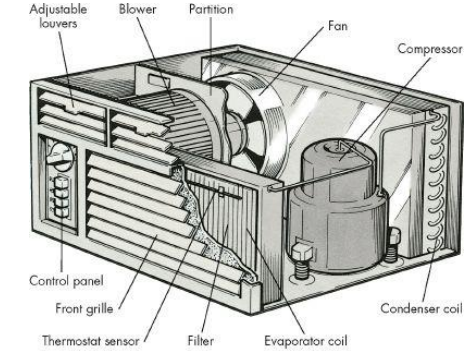

Structure

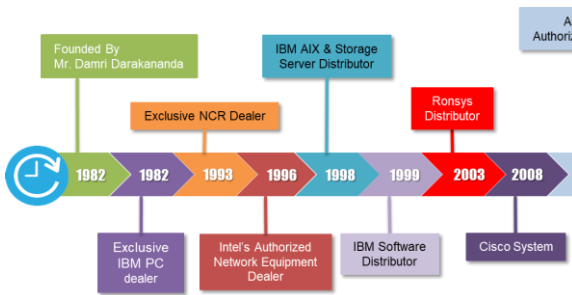

Timeline/Roadmap

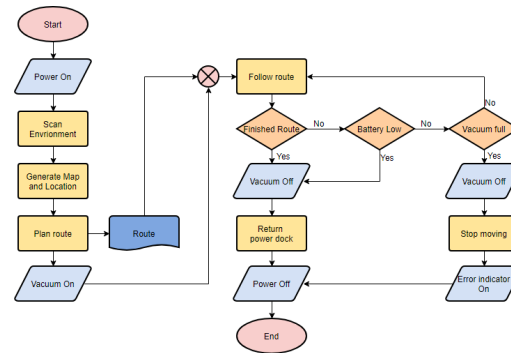

Flowchart

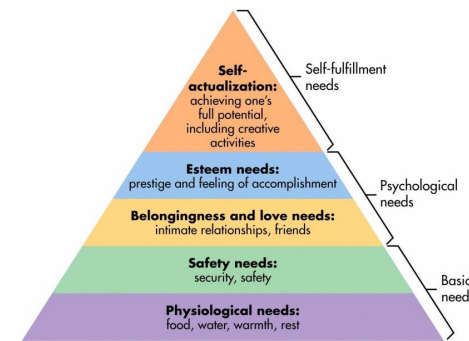

Hierarchy

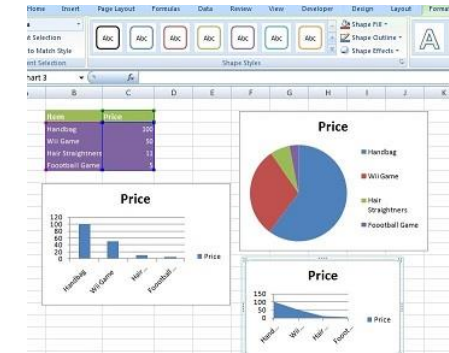
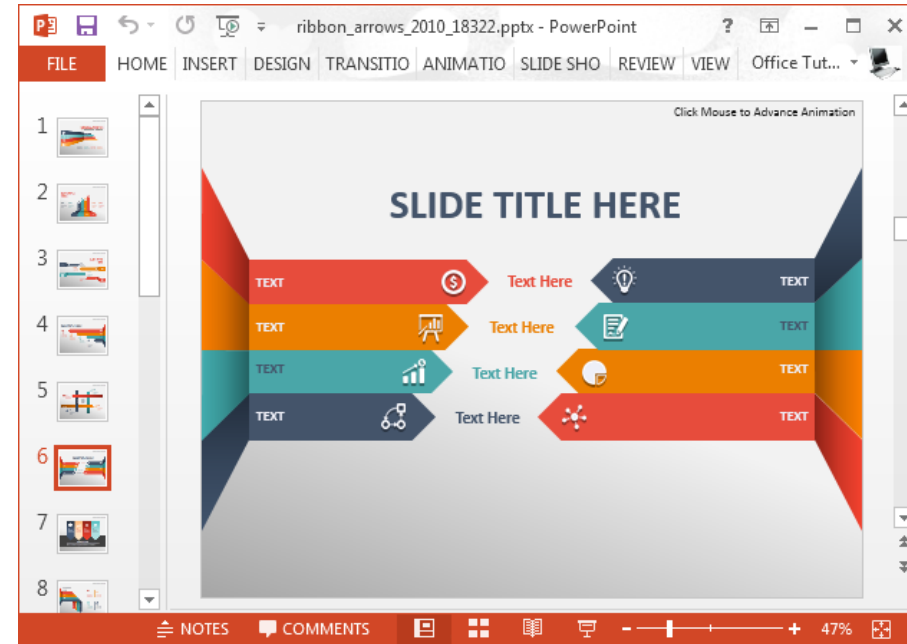

Chart & Graph

6. Start designing



There are several tools that provide infographic templates, such as Canva and PowerPoint. Common tools such as Photoshop and Illustrator are for the professionals.

7. Test on different devices/platforms

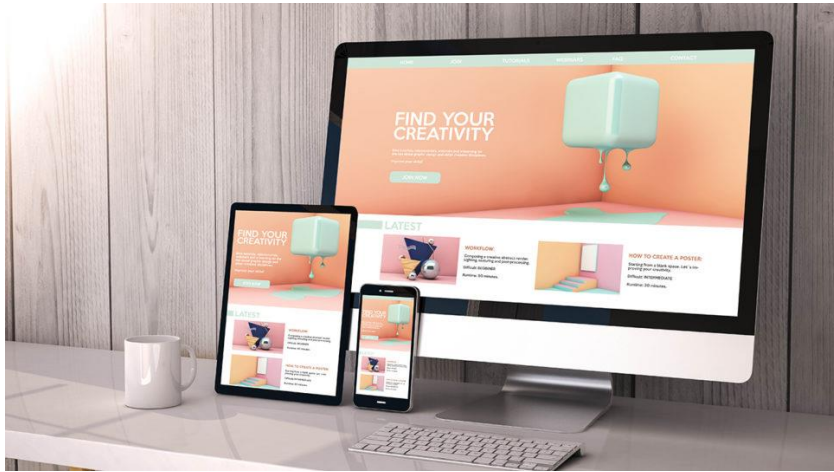

➤ Designs look differently on different devices.

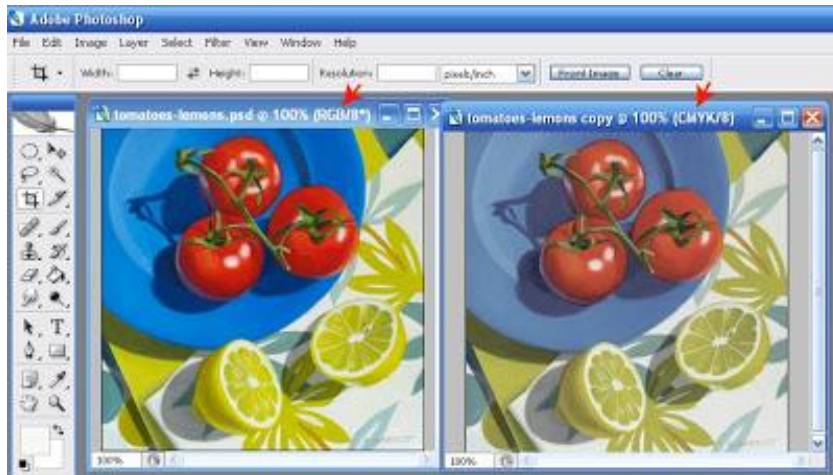

➤ Different color systems on screen and in prints (RGB/CMYK).